



Description

The SE5119 is an efficient linear voltage regulator. It has extra low dropout voltage. At light loads the typical dropout voltage is 15mV, at full load the typical dropout voltage is 800mV. The output voltage accuracy is better than 2%.

The SE5119 has low ground current at 65uA, so it can help prolong battery life. The SE5119 is specially designed for hand-held, battery-powered devices.

Features

- Typical 175mV dropout voltage at 150mA.
- Low Ground current at 65uA. (Typ.)
- Guaranteed 500mA output over the full operating temperature range.
- Extremely tight load and line regulation.
- Low temperature coefficient.
- Current and thermal limiting.
- No-load stability.
- Standard SOT-89-3L package.

Pin Configuration

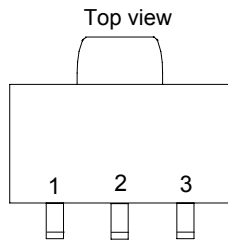

SOT-89

Applications

- Active SCSI terminators.
- Post regulators for switching supplies.
- Battery chargers.
- High-efficiency linear power supplies.
- Computer motherboard, display, graphic card DC/DC converter, such as 5V to 3.3V, 3.3V to 2.8V or 3.3V to 2.5V.

Typical Application

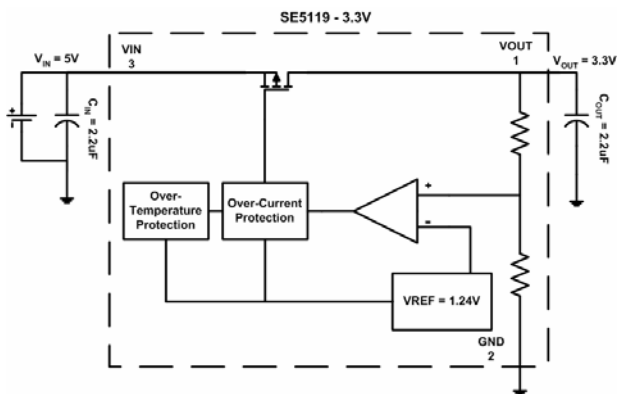

Ordering Information

- SE5119
- PIN (1=>3): 1. G: OUT/GND/IN
 - 2. N: GND/IN/OUT
 - Package Type: 1. K: SOT-89-3L
 - Output Voltage: 1. A: V_{OUT} = 3.3V
 - 2. B: V_{OUT} = 2.8V
 - 3. C: V_{OUT} = 2.5V
 - 4. D: V_{OUT} = 1.8V
 - 5. E: V_{OUT} = 1.5V
 - 6. F: V_{OUT} = 3.0V



Absolute Maximum Ratings⁽¹⁾

Supply Input Voltage (V_{IN})+6V
 Power Dissipation (P_D) Internally Limited ⁽³⁾
 Junction Temperature (T_J) 150°C
 Lead Temperature (soldering, 5 sec.) 260°C
 Storage Temperature (T_S) -10°C to +150°C

Operating Ratings⁽²⁾

Supply Input Voltage (V_{IN}) +2.8V to +5.5V
 Junction Temperature (T_J) 0°C to +125°C
 Package Thermal
 Resistance 180°C/W

Electrical Characteristics

$V_{IN} = 5V$; $C_{IN} = 2.2\mu F$; $C_{OUT} = 2.2\mu F$, $I_{OUT} = 10mA$; $T_J = 25^\circ C$, unless otherwise specified.

Symbol	Parameter	Conditions	Min	Typ	Max	Units	
V_{OUT}	Output Voltage Accuracy	SE5119-1.5V($V_{IN}=3.3V$)	1.470	1.5	1.530	V	
		SE5119-1.8V($V_{IN}=3.3V$)	1.764	1.8	1.836		
		SE5119-2.5V	2.450	2.5	2.550		
		SE5119-2.8V	2.744	2.8	2.856		
		SE5119-3.0V	2.940	3.0	3.060		
		SE5119-3.3V	3.234	3.3	3.366		
$\Delta V_{OUT} / \Delta T$	Output Voltage Temperature Coefficient	Note 4	--	50	--	ppm/°C	
$\Delta V_{OUT} / V_{OUT}$	Line Regulation	$V_{IN} = (V_{OUT} + 1)V$ to 5.5V	--	1	--	%/V	
$\Delta V_{OUT} / V_{OUT}$	Load Regulation ⁽⁵⁾	$V_{IN} = (V_{OUT} + 1)V$	$I_{OUT} = 10mA$ to 250mA	--	1	--	%
			$I_{OUT} = 10mA$ to 500mA	--	1.5	--	
$V_{IN} - V_{OUT}$	Dropout Voltage ⁽⁶⁾ ($V_{OUT} > 2V$)	$I_{OUT} = 10mA$	--	15	--	mV	
		$I_{OUT} = 150mA$	--	175	--		
		$I_{OUT} = 250mA$	--	320	--		
		$I_{OUT} = 500mA$	--	800	--		
$T_{PROTECTION}$	Thermal Protection	Thermal Protection Temperature	--	150	--	°C	
		Protection Hysterisys	--	20	--	°C	
PSRR	Ripple Rejection	$f = 120Hz$	--	51	--	dB	
I_{GROUND}	Ground Current	$I_{OUT} = 10mA$	--	65	--	uA	
I_{LIMIT}	Current Limit	$V_{OUT} = 0V$	--	700	--	mA	



Note 1: Exceeding the absolute maximum rating may damage the device.

Note 2: The device is not guaranteed to function outside its operating rating.

Note 3: The maximum allowable power dissipation at any TA (ambient temperature) is calculated using: $P_{D(MAX)} = (T_{J(MAX)} - T_A) / \theta_{JA}$. Exceeding the maximum allowable power dissipation will result in excessive die temperature, and the regulator will go into thermal shutdown. See Table 1 and the "Thermal Considerations" section for details.

Note 4: Output voltage temperature coefficient is the worst-case voltage change divided by the total temperature range.

Note 5: Regulation is measured at constant junction temperature using low duty cycle pulse testing. Parts are tested for load regulation in the load range from 100 μ A to 500mA. Changes in output voltage due to heating effects are covered by the thermal regulation specification.

Note 6: Dropout voltage is defined as the input to output differential at which the output voltage drops 2% below its nominal value measured at 1V differential.



Application Hints

Like any Low dropout regulator, SE5119 requires external capacitors to ensure stability. The external capacitors must be carefully selected to ensure the performances.

Input Capacitor:

An Input Capacitor of at least 2.2uF is required.

Ceramic or Tantalum can be used. The value can be increased without upper limit.

Output Capacitor:

An Output Capacitor is required for look stability. It must be located no more than 1cm away from the V_{OUT} pin, and connected directly between V_{OUT} and GND pins. The minimum value is 2.2uF but once again its value can be increased without limit.

Thermal Consideration

It is important that the thermal limit of the package should not be exceeded. The SE5119 has built-in thermal protection. When the thermal limit is exceeded, the IC will enter protection, and the V_{OUT} will be reset to zero. The power dissipation for a given application can be calculated as follows:

The Power Dissipation (P_D) is

$$P_D = I_{OUT} * [V_{IN} - V_{OUT}]$$

The thermal limit of the package is then limited to

$P_{D(MAX)} = [T_J - T_A]/\theta_{JA}$ where T_J is the junction temperature, T_A is ambient temperature, and θ_{JA} is around 180°C/W for SE5119. SE5119 is designed to enter thermal protection at 150°C. For example, if T_A is 25°C then the max P_D is limited to about 0.7W. In other words, if $I_{OUT(MAX)} = 500mA$, then $[V_{IN} - V_{OUT}]$ can not exceed 1.4V.



Typical Performance Characteristics

($V_{IN} = 5V$, $C_{IN} = 2.2\mu F$, $C_{OUT} = 2.2\mu F$, $T_A = 25^\circ C$, unless otherwise noted.)

Load Regulation

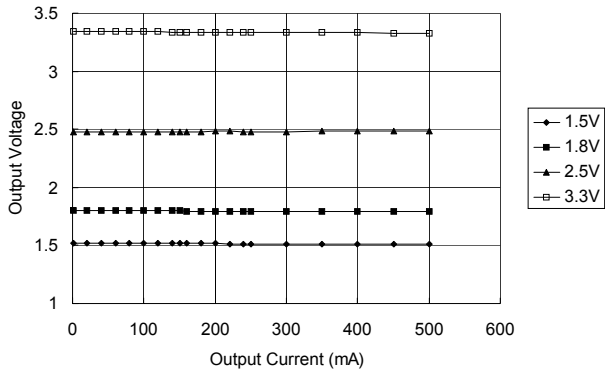

Output Voltage vs Temperature

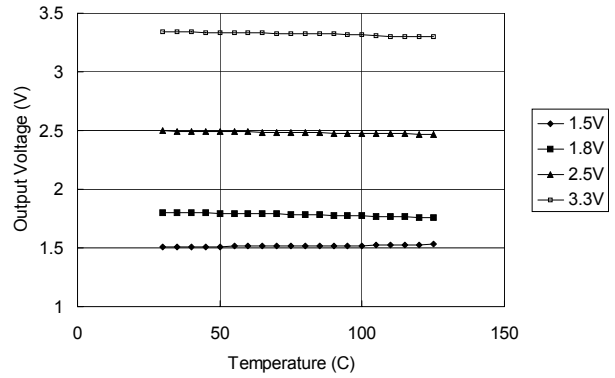

Quiescent Current vs Temperature
(Output Voltage @ 2.5V)

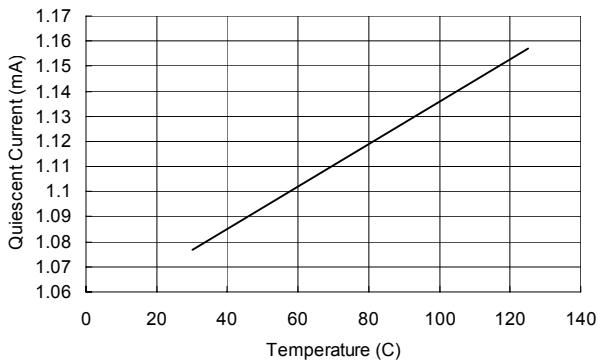

Dropout Voltage vs Output Current

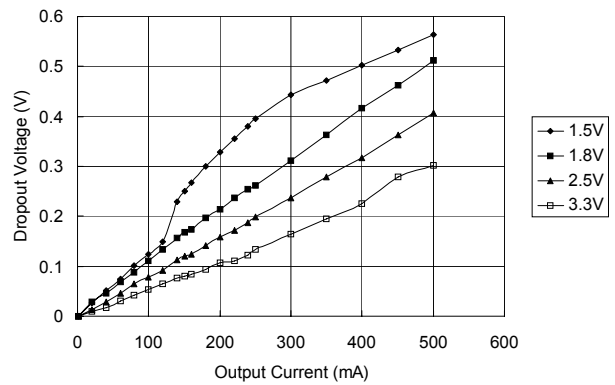

Line Transient

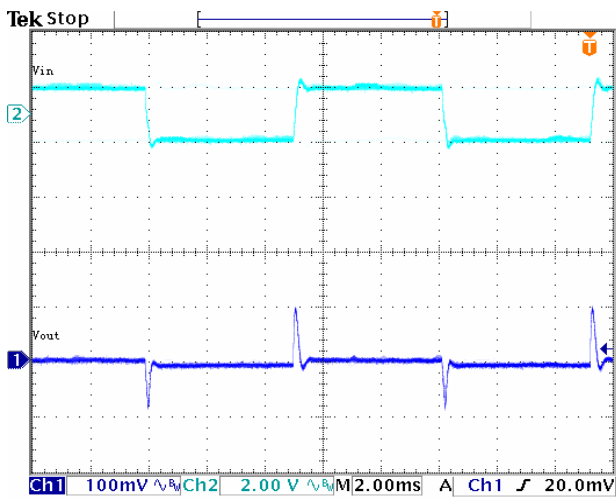

Load Transient (10mA – 500mA)

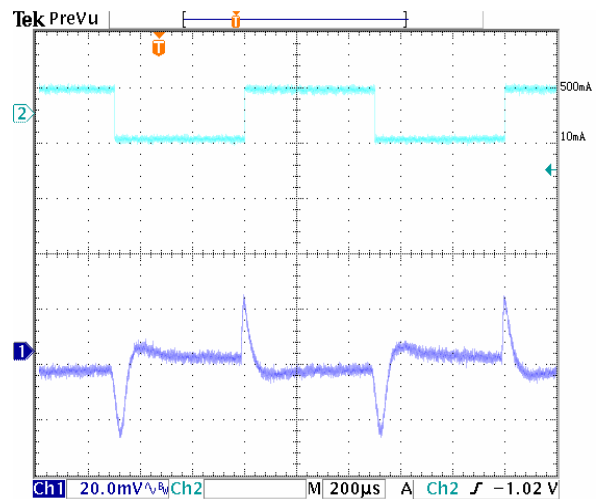



Outline Drawing for SOT-89

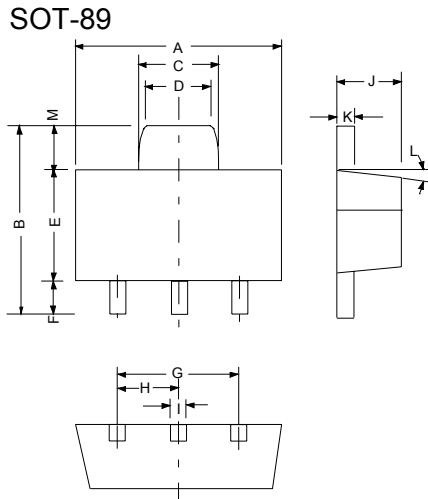

DIMENSIONS				
DIM ^N	INCHES		MM	
	MIN	MAX	MIN	MAX
A	0.173	0.181	4.400	4.600
B	0.159	0.167	4.050	4.250
C	0.067	0.075	1.700	1.900
D	0.051	0.059	1.300	1.500
E	0.094	0.102	2.400	2.600
F	0.035	0.047	0.890	1.200
G	0.118REF		3.00REF	
H	0.059REF		1.50REF	
I	0.016	0.020	0.400	0.520
J	0.055	0.063	1.400	1.600
K	0.014	0.016	0.350	0.410
L	10°TYP		10°TYP	
M	0.028REF		0.70REF	

Contact Information

Seaward Electronics Incorporated – China

Rm 1605, Building 1, International Pioneering Park, #1 Shangdi Xinxi Rd

Haidian District, Beijing 100085, China

Tel: 86-10-8289-5700/01/05

Fax: 86-10-8289-5706

Email: sales@seawardinc.com.cn

Seaward Electronics Corporation – Taiwan

2F, #181, Sec. 3, Minguan East Rd,

Taipei, Taiwan R.O.C

Tel: 886-2-2712-0307

Fax: 886-2-2712-0191

Email: sales@seawardinc.com.tw

Seaward Electronics Incorporated – North America

1512 Centre Pointe Dr.

Milpitas, CA95035, USA

Tel: 1-408-821-6600

Last Updated - 4/21/2006