



SOT-23 Plastic-Encapsulate Transistors

S9015 TRANSISTOR (PNP)

FEATURES

- Complementary to S9014

MARKING: M6

MAXIMUM RATINGS ($T_A=25^{\circ}\text{C}$ unless otherwise noted)

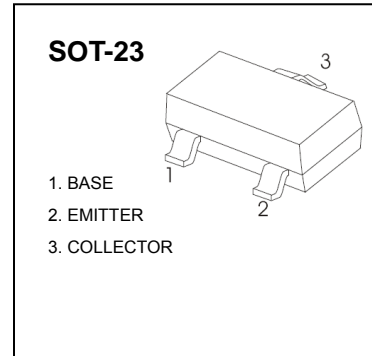

Symbol	Parameter	Value	Units
V_{CB0}	Collector-Base Voltage	-50	V
V_{CEO}	Collector-Emitter Voltage	-45	V
V_{EBO}	Emitter-Base Voltage	-5	V
I_C	Collector Current -Continuous	-0.1	A
P_C	Collector Power Dissipation	0.2	W
T_j	Junction Temperature	150	$^{\circ}\text{C}$
T_{stg}	Storage Temperature	-55-150	$^{\circ}\text{C}$

ELECTRICAL CHARACTERISTICS ($T_{amb}=25^{\circ}\text{C}$ unless otherwise specified)

Parameter	Symbol	Test conditions	MIN	TYP	MAX	UNIT
Collector-base breakdown voltage	$V_{(BR)CBO}$	$I_C = -100\mu\text{A}, I_E = 0$	-50			V
Collector-emitter breakdown voltage	$V_{(BR)CEO}$	$I_C = -0.1\text{mA}, I_B = 0$	-45			V
Emitter-base breakdown voltage	$V_{(BR)EBO}$	$I_E = -100\mu\text{A}, I_C = 0$	-5			V
Collector cut-off current	I_{CBO}	$V_{CB} = -50\text{V}, I_E = 0$			-0.1	μA
Emitter cut-off current	I_{EBO}	$V_{EB} = -5\text{V}, I_C = 0$			-0.1	μA
DC current gain	h_{FE}	$V_{CE} = -5\text{V}, I_C = -1\text{mA}$	200		1000	
Collector-emitter saturation voltage	$V_{CE(sat)}$	$I_C = -100\text{mA}, I_B = -10\text{mA}$			-0.3	V
Base-emitter saturation voltage	$V_{BE(sat)}$	$I_C = -100\text{mA}, I_B = -10\text{mA}$			-1	V
Transition frequency	f_T	$V_{CE} = -5\text{V}, I_C = -10\text{mA}$ $f = 30\text{MHz}$	150			MHz

CLASSIFICATION OF h_{FE}

Rank	L	H
Range	200-450	450-1000

Typical Characteristics

S9015

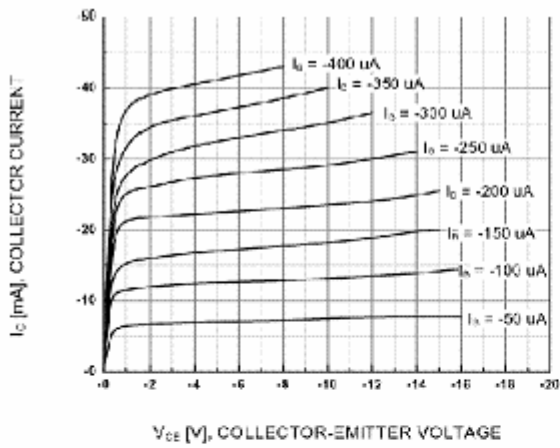

Figure 1. Static Characteristic

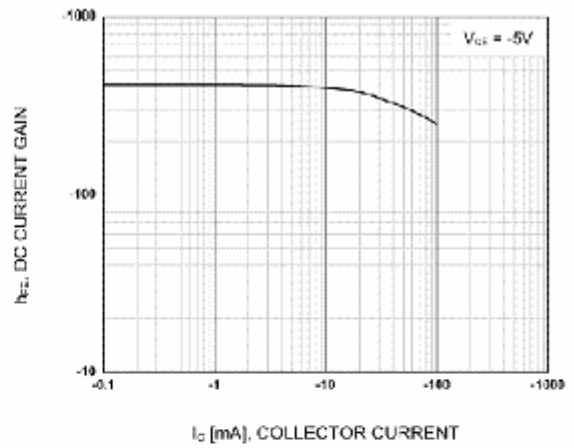

Figure 2. DC current Gain

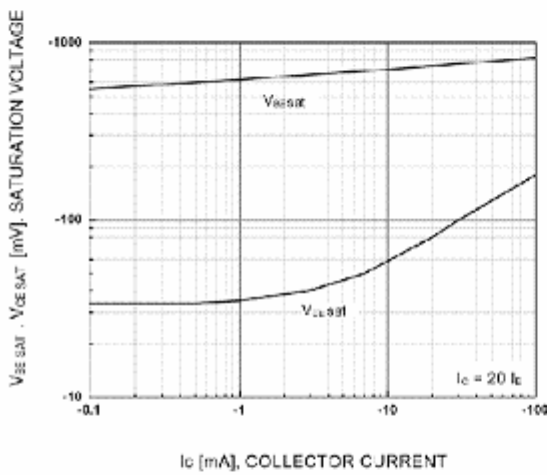

Figure 3. Base-Emitter Saturation Voltage
Collector-Emitter Saturation Voltage

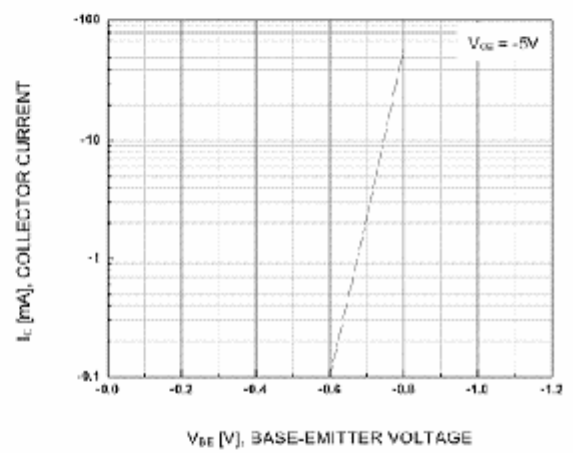

Figure 4. Base-Emitter On Voltage

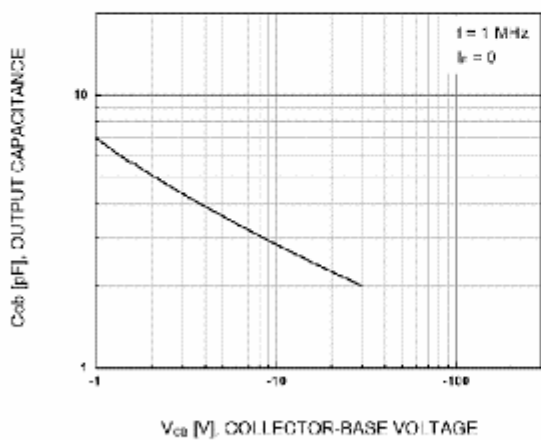

Figure 5. Collector Output Capacitance

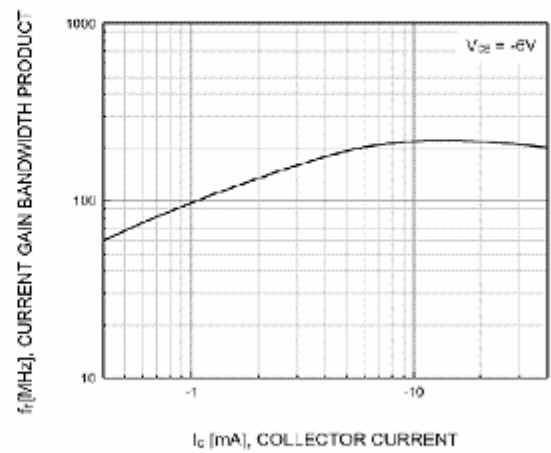

Figure 6. Current Gain Bandwidth Product